

# Kansas State University Polytechnic Organization

## Administration

Dr. Charles Taber  
Sr. Vice President / Provost

Dr. Alysia Starkey  
Interim CEO and Dean

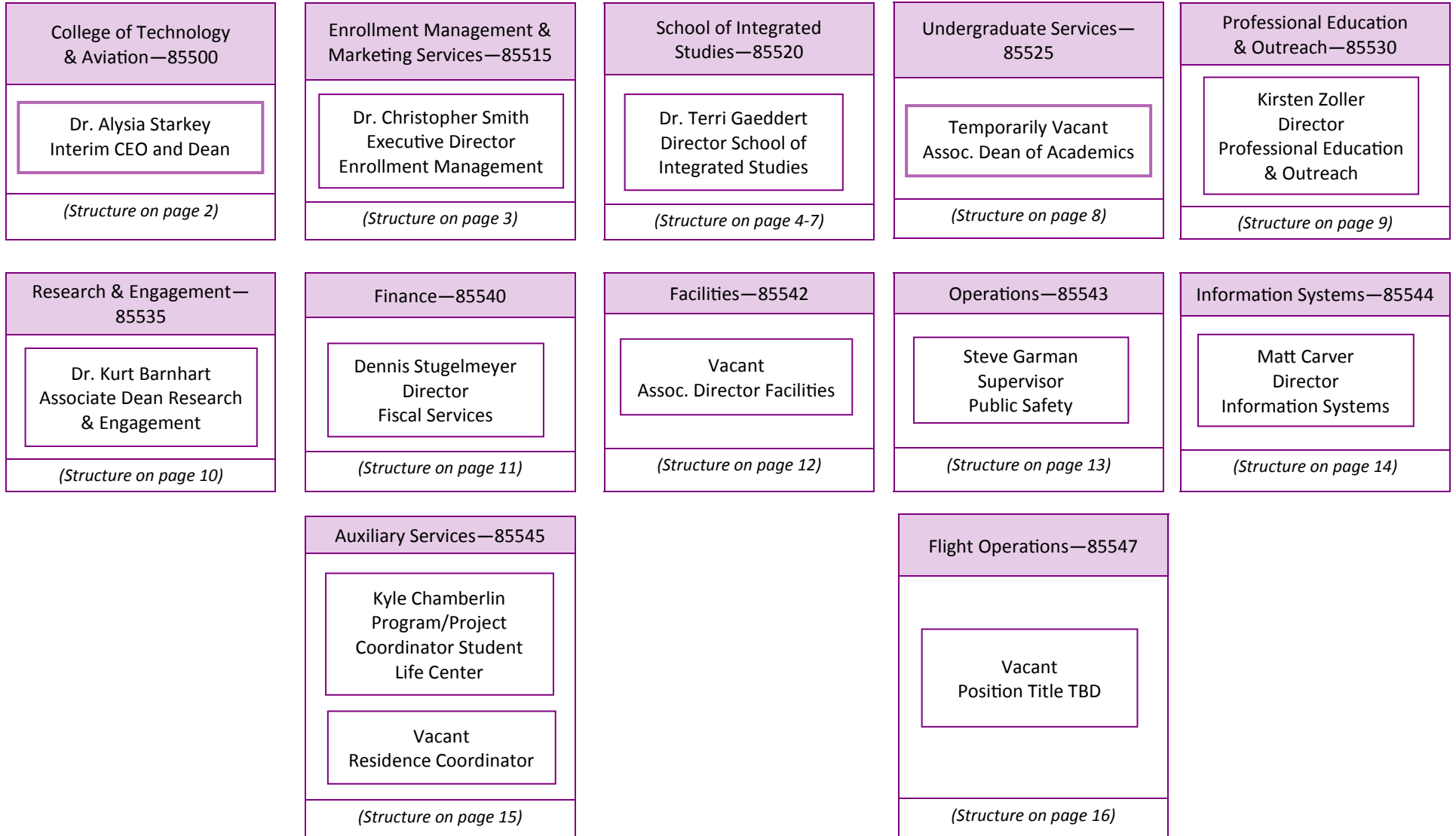

**Kansas State University Polytechnic Organization**  
**College of Technology & Aviation—85500**

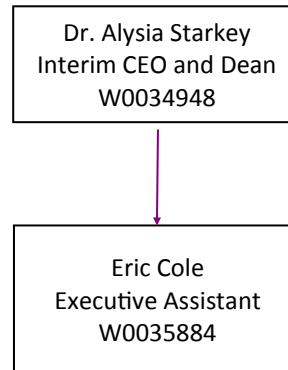

# Kansas State University Polytechnic Organization

## Enrollment Management & Marketing Services—85515

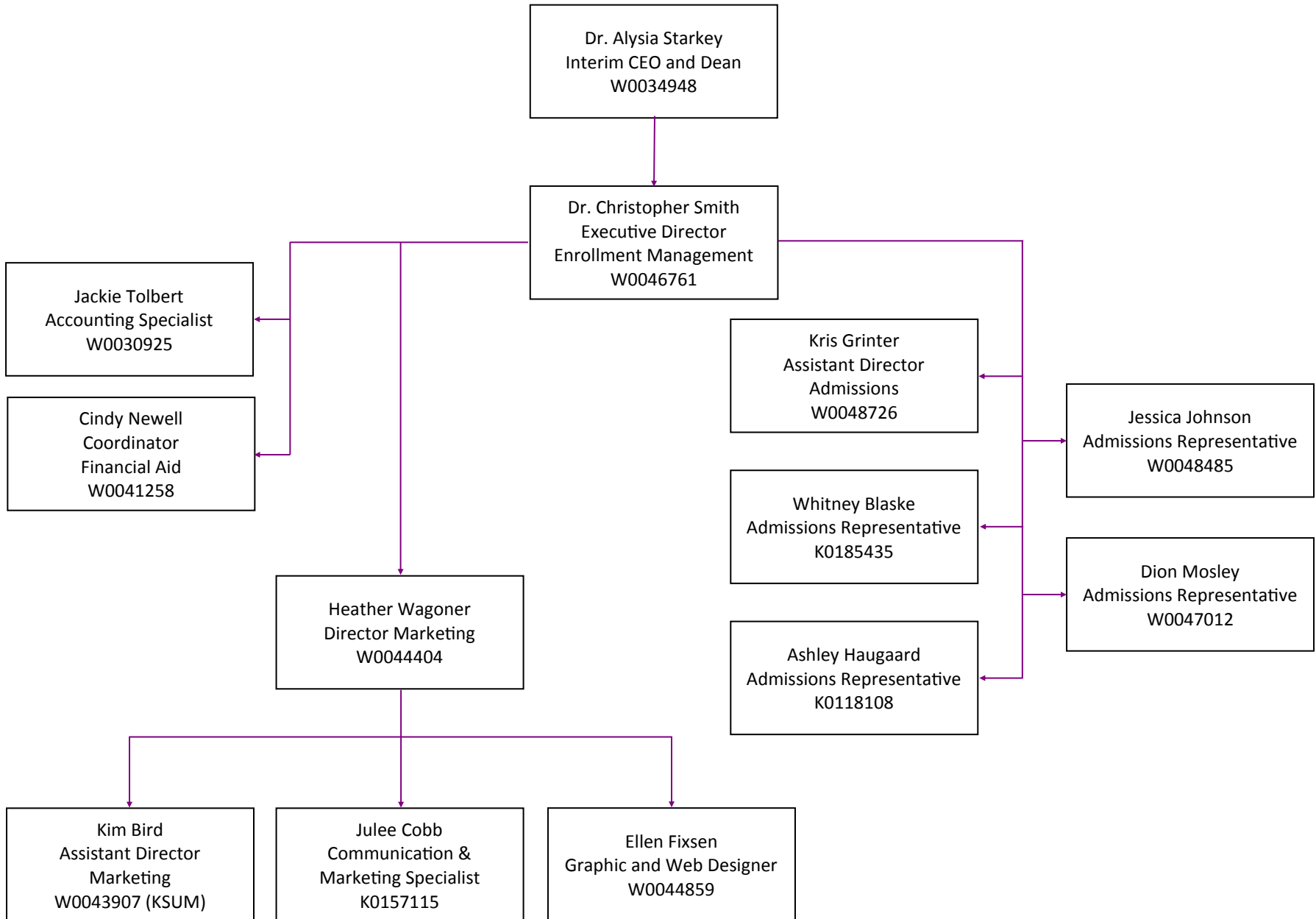

# Kansas State University Polytechnic Organization

## School of Integrated Studies—85520—Aviation

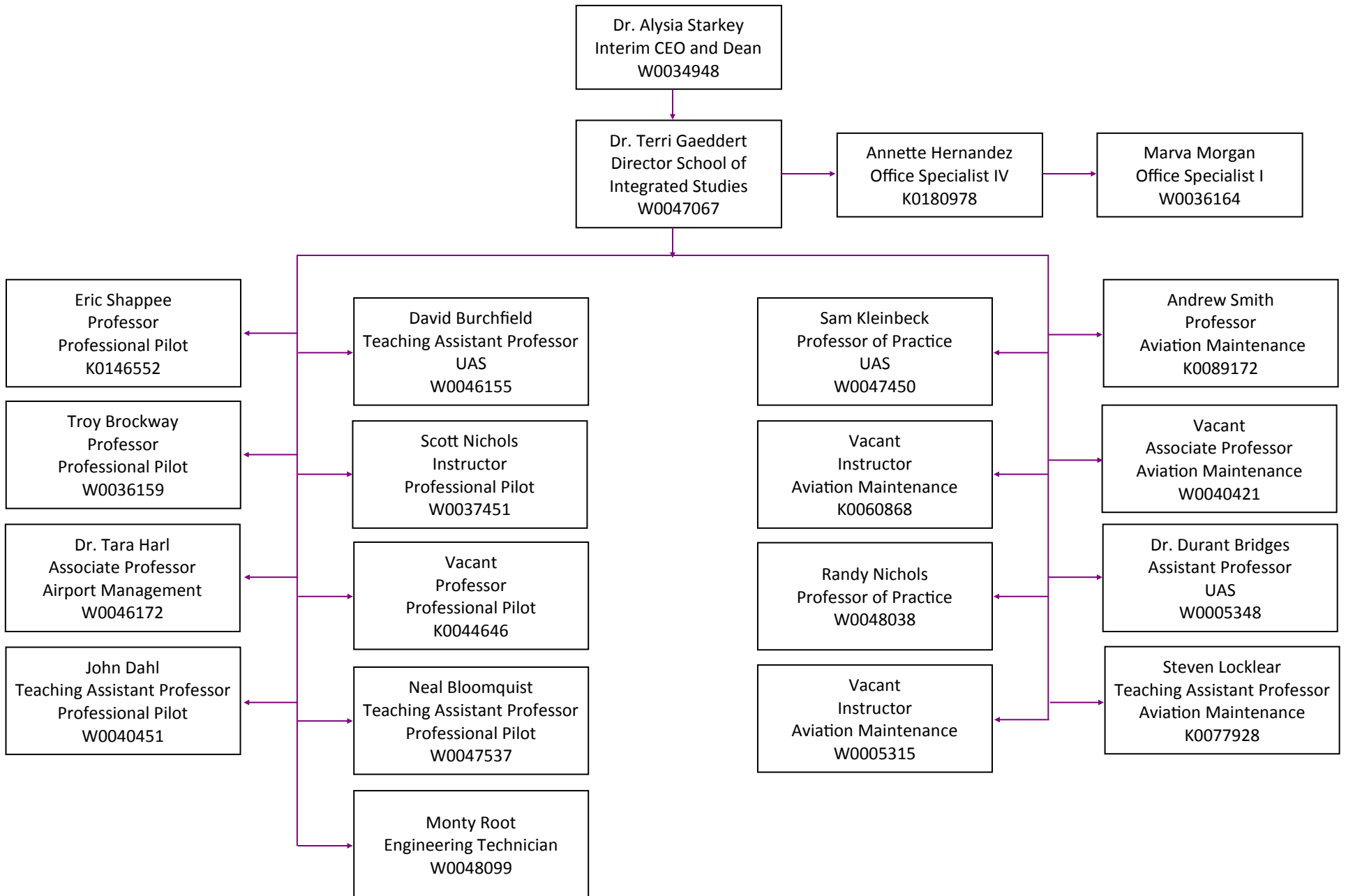

# Kansas State University Polytechnic Organization

## School of Integrated Studies—85520—Engineering Technology

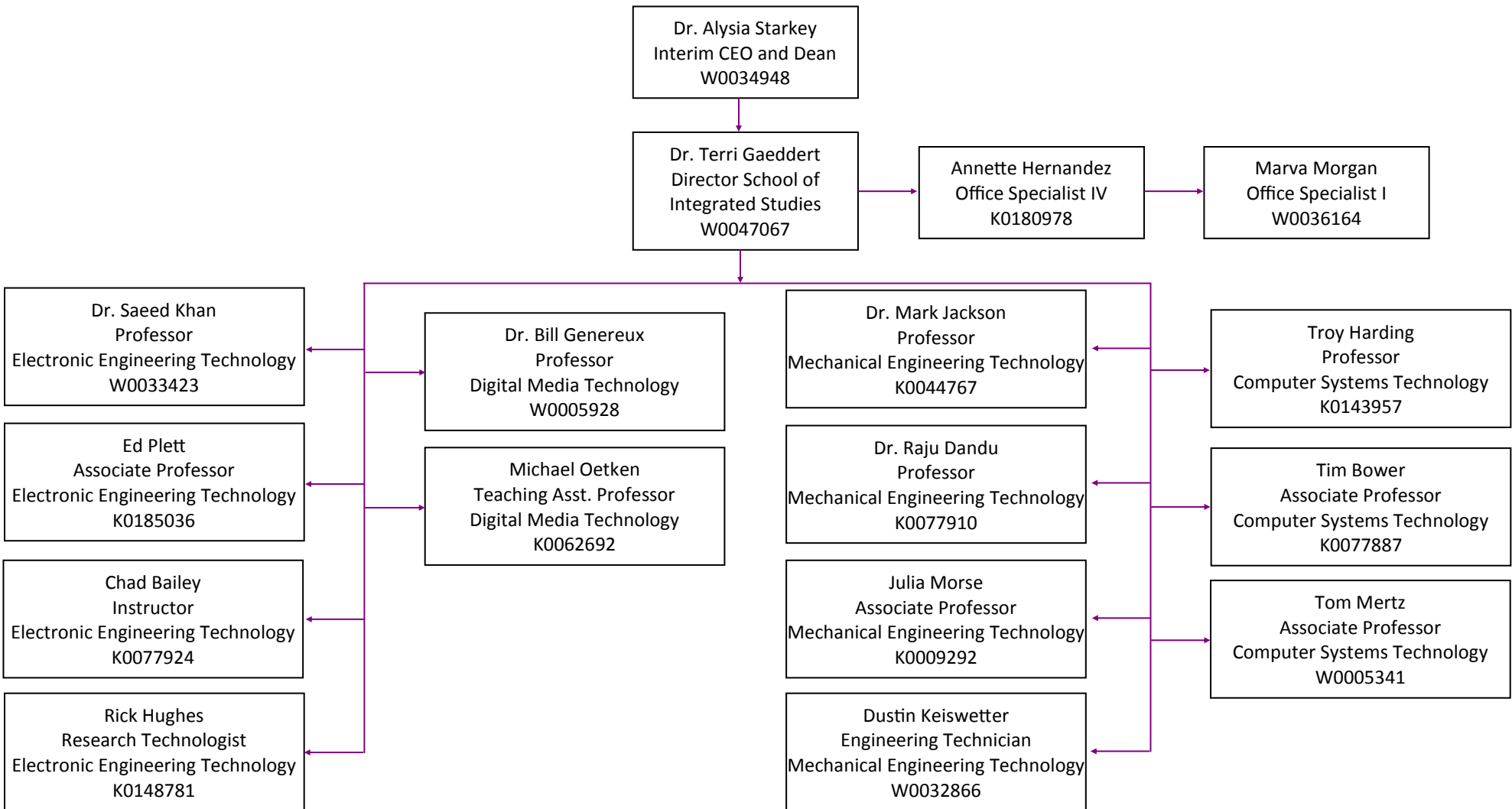

# Kansas State University Polytechnic Organization

## School of Integrated Studies—85520—Communications, Humanities & Social Sciences

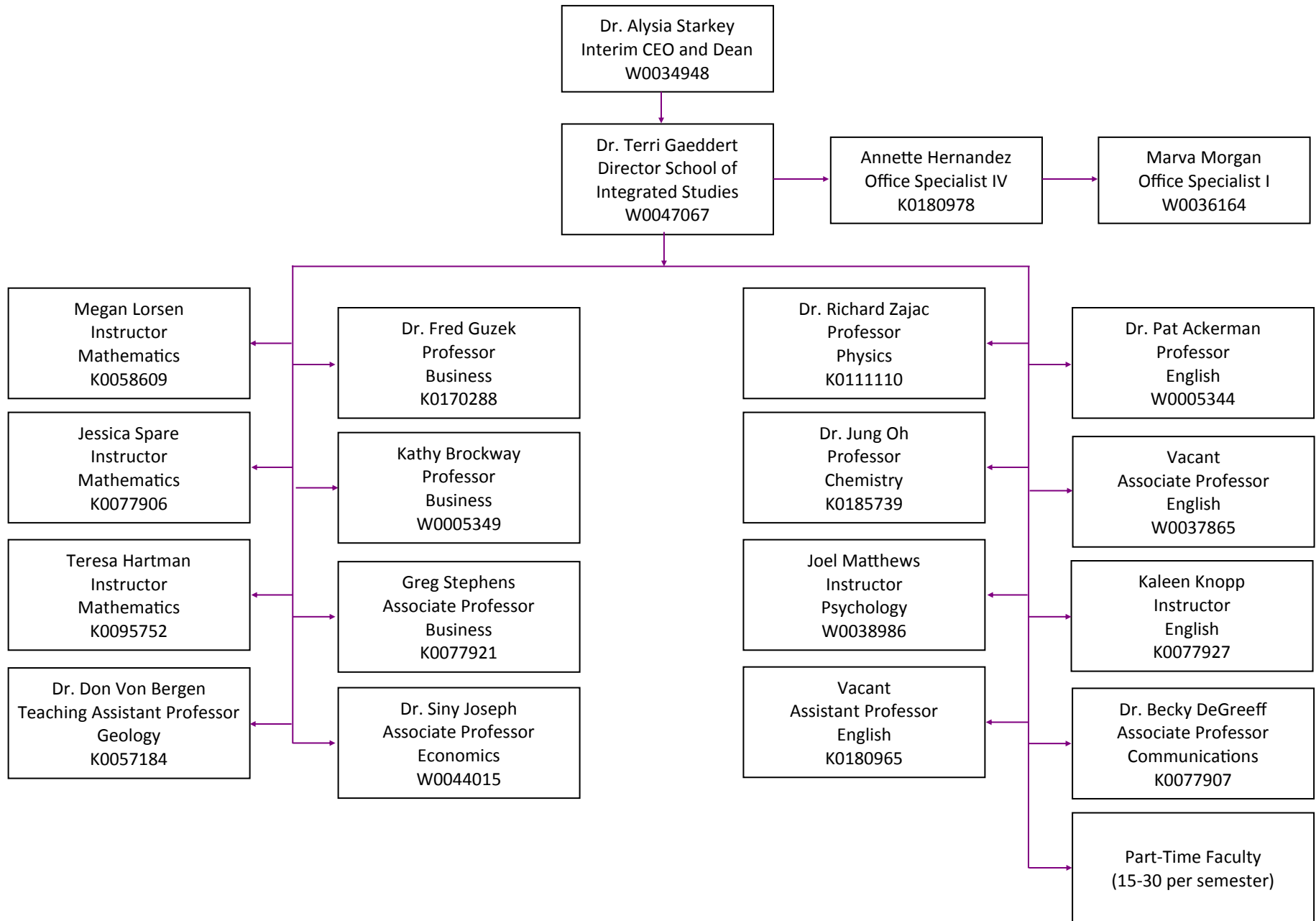

# Kansas State University Polytechnic Organization

## School of Integrated Studies—85520—Intercampus Academic Programs

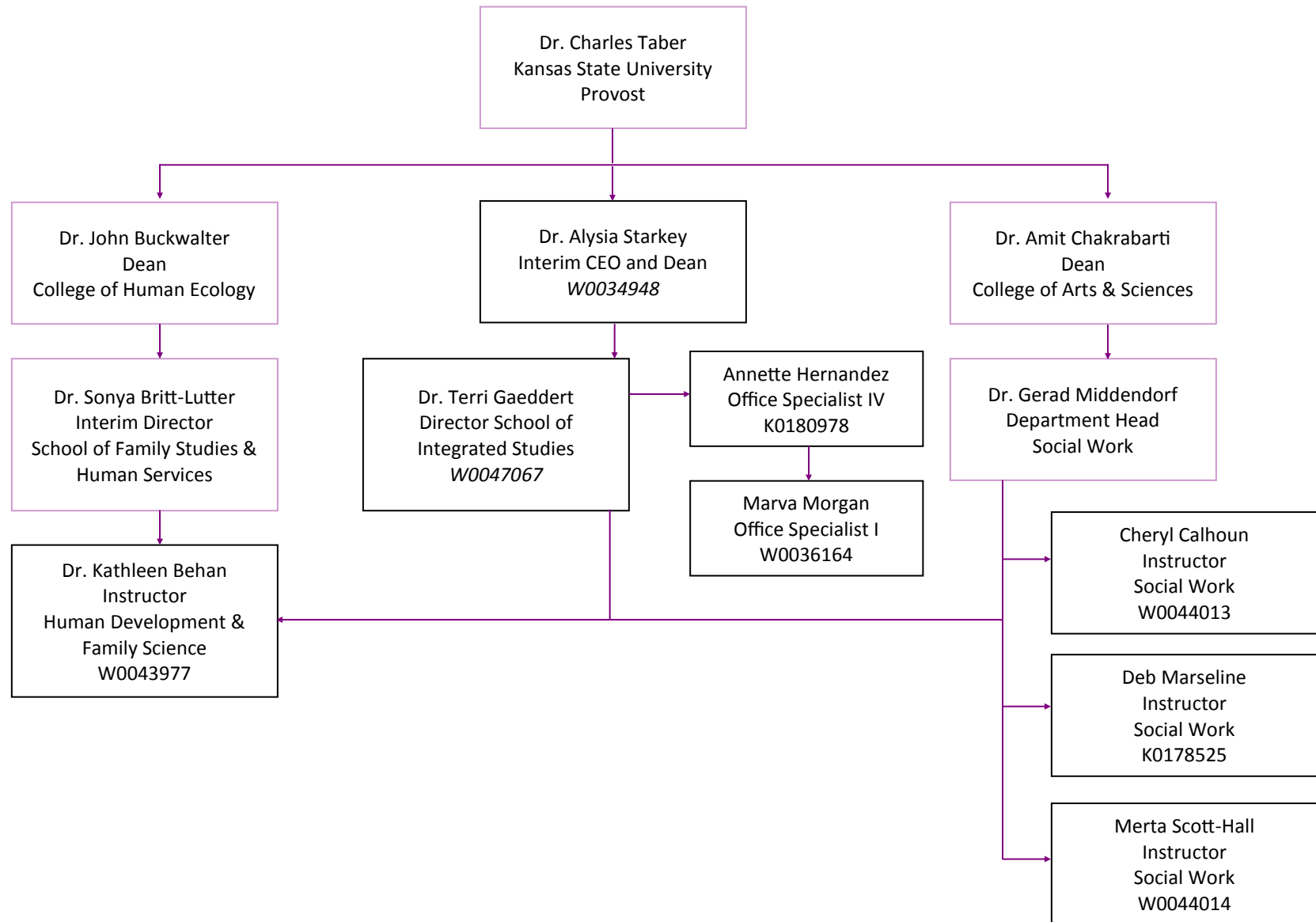

# Kansas State University Polytechnic Organization

## Undergraduate Services—85525

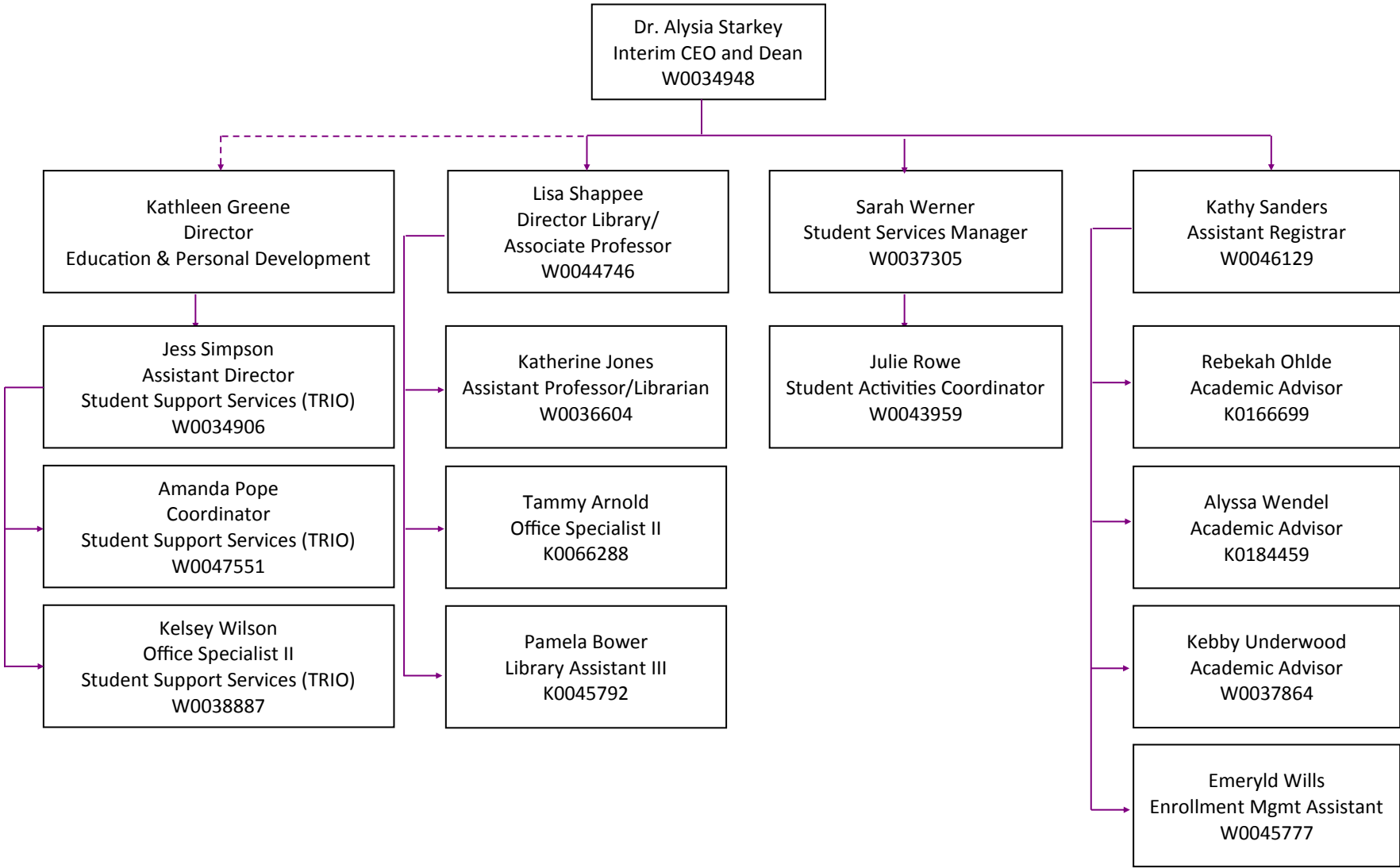



**Kansas State University Polytechnic Organization**  
**Professional Education & Outreach—85530**

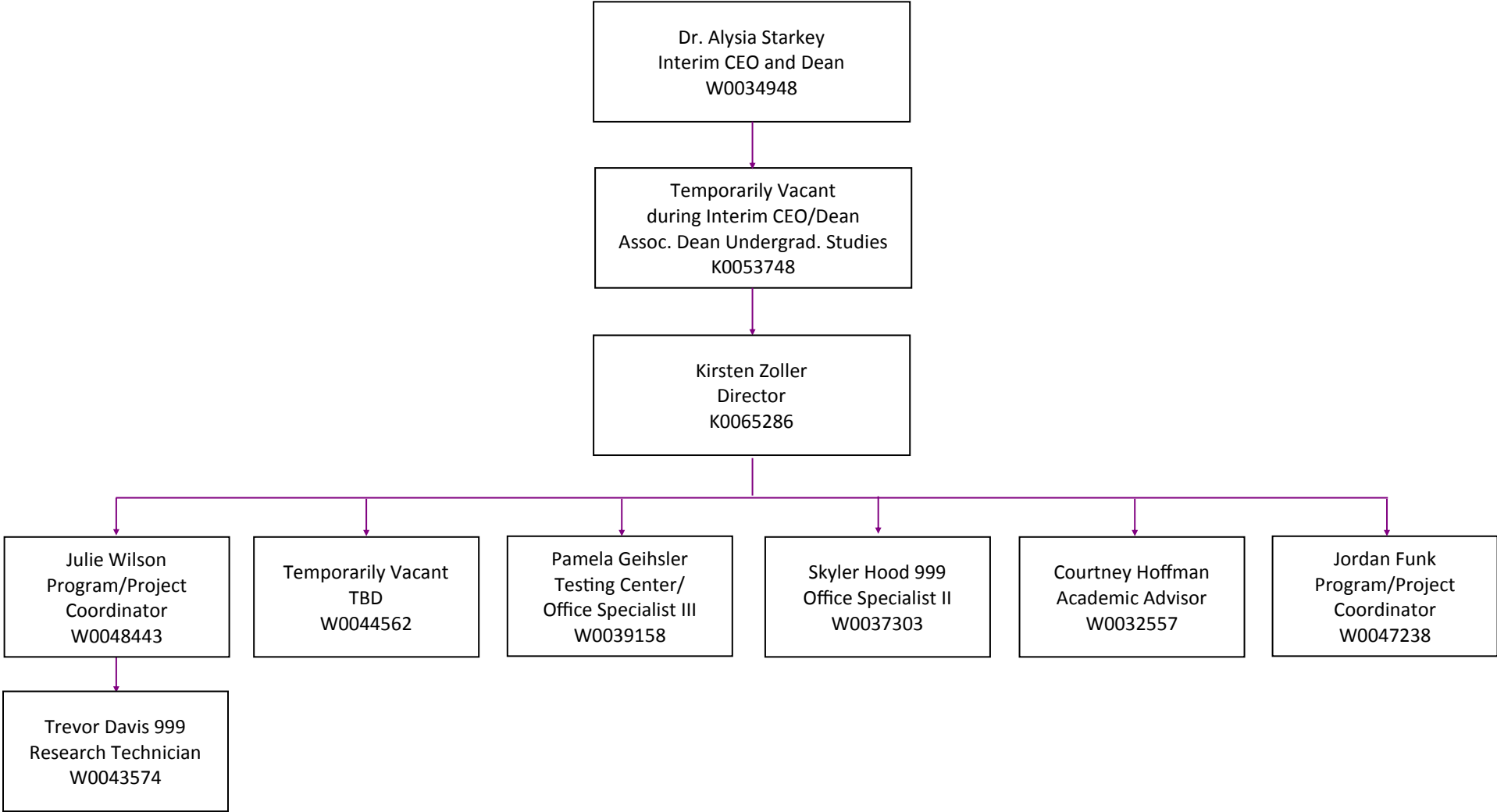

# Kansas State University Polytechnic Organization

## Research & Engagement—85535

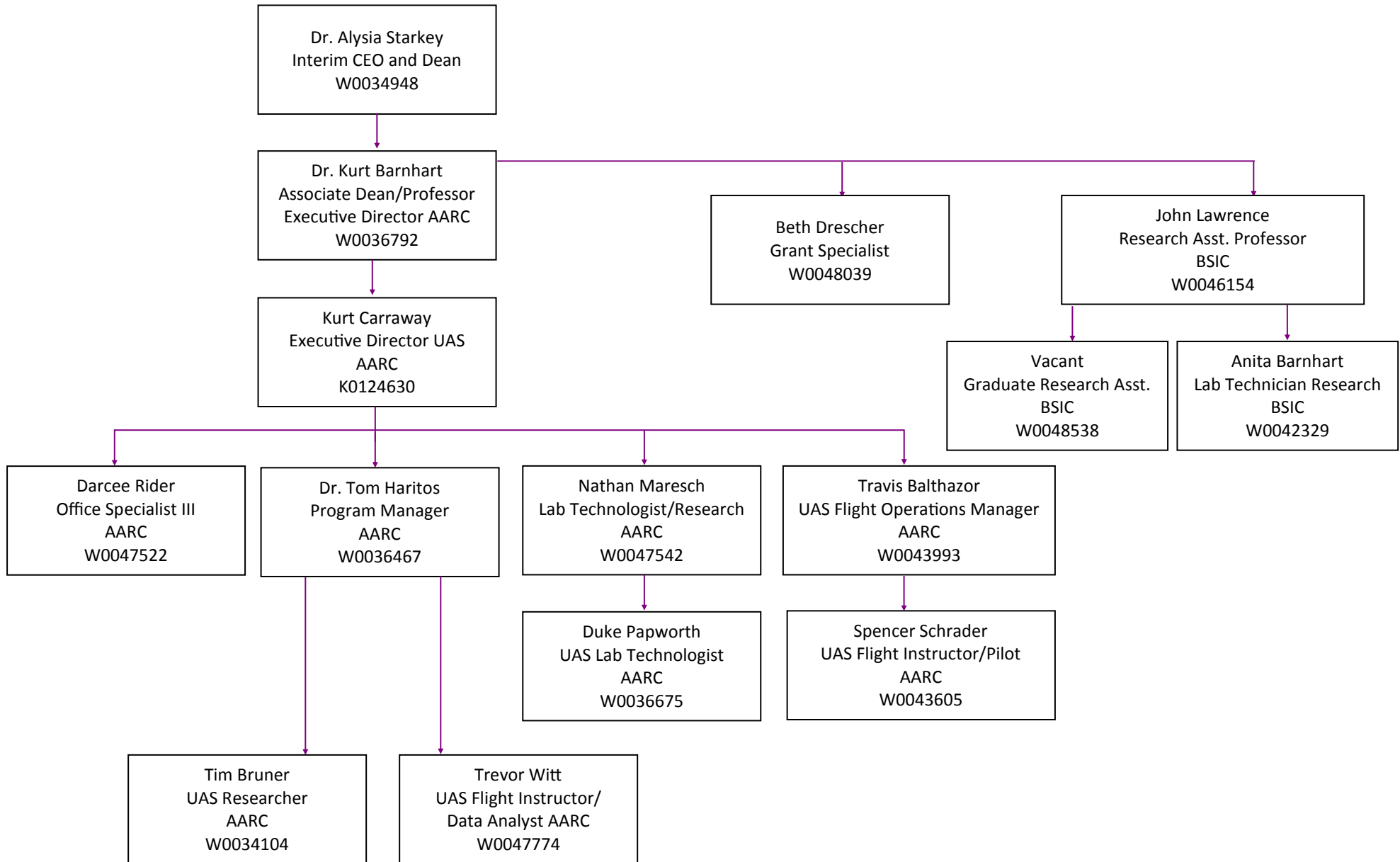

**Kansas State University Polytechnic Organization**  
**Finance—85540**

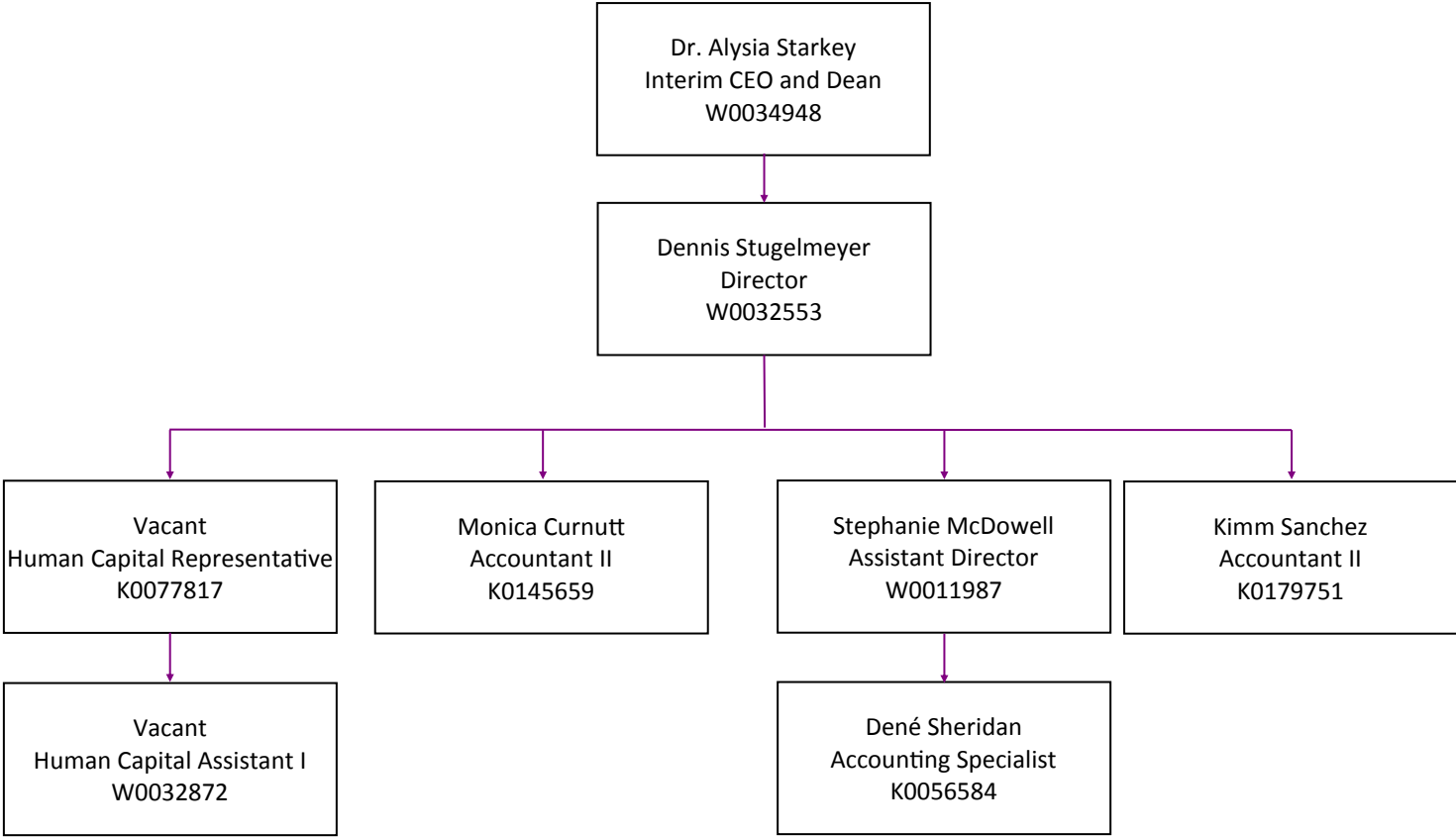

# Kansas State University Polytechnic Organization

## Facilities—85542

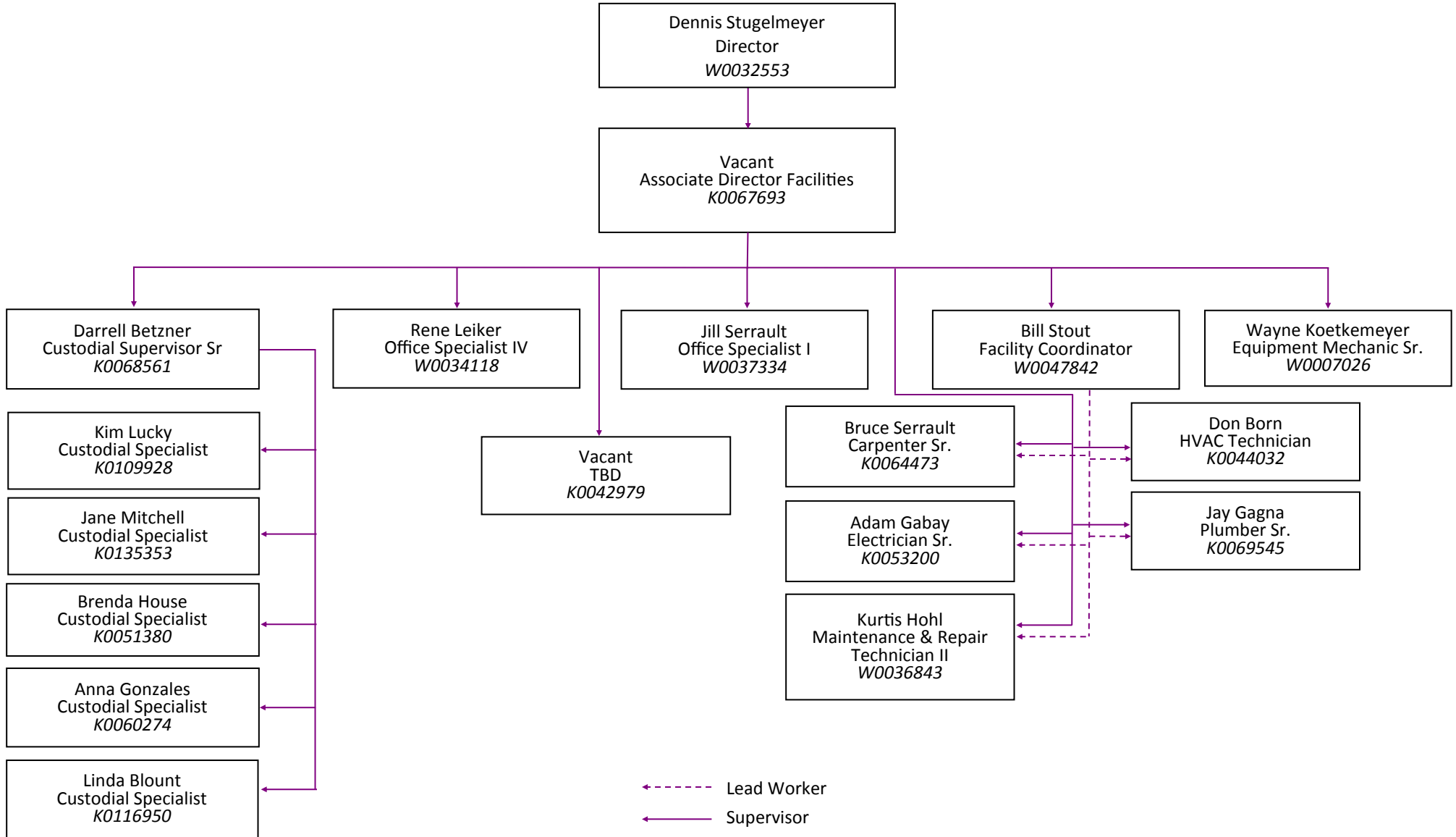

# Kansas State University Polytechnic Organization

## Operations—85543

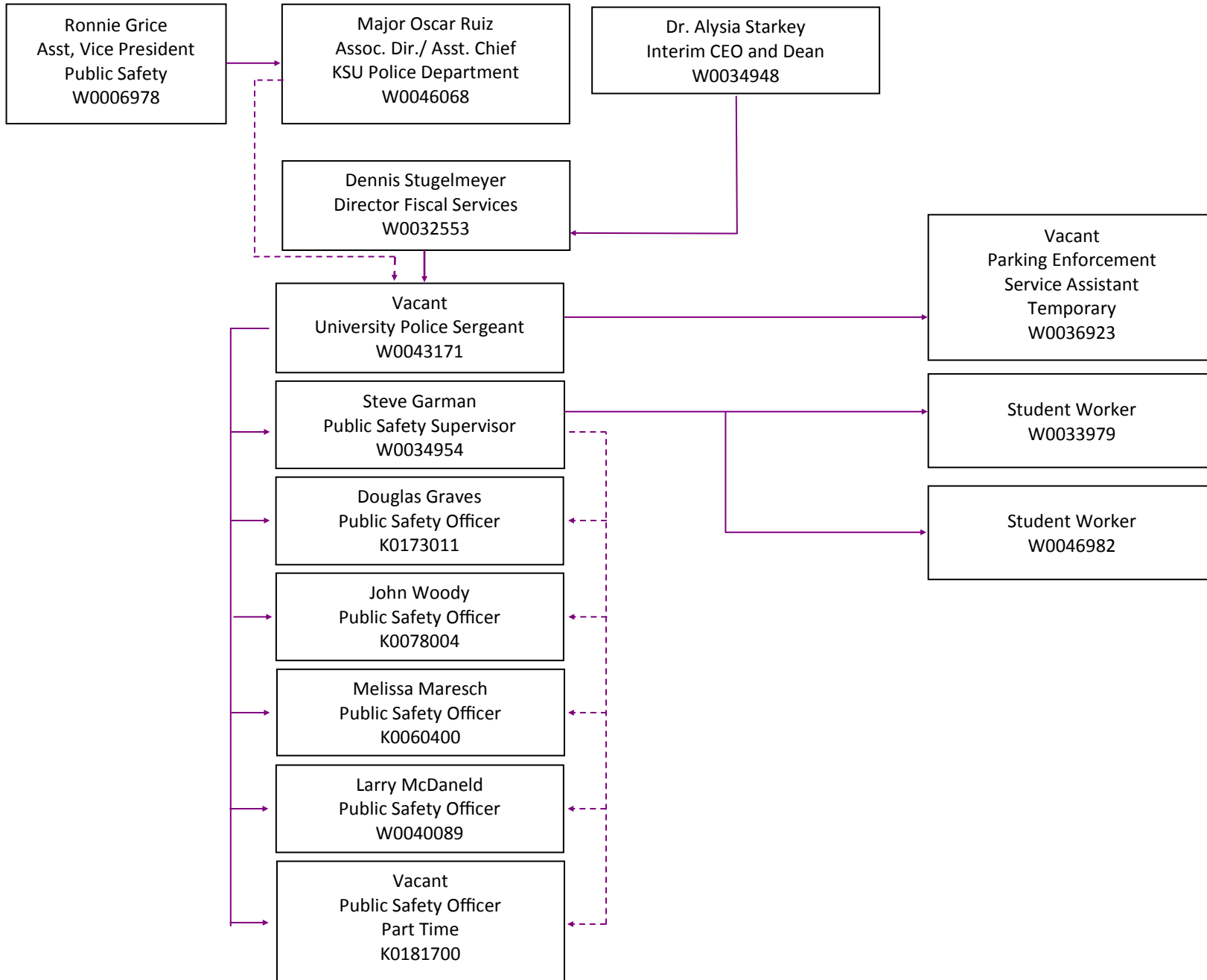

# Kansas State University Polytechnic Organization Information Systems—85544

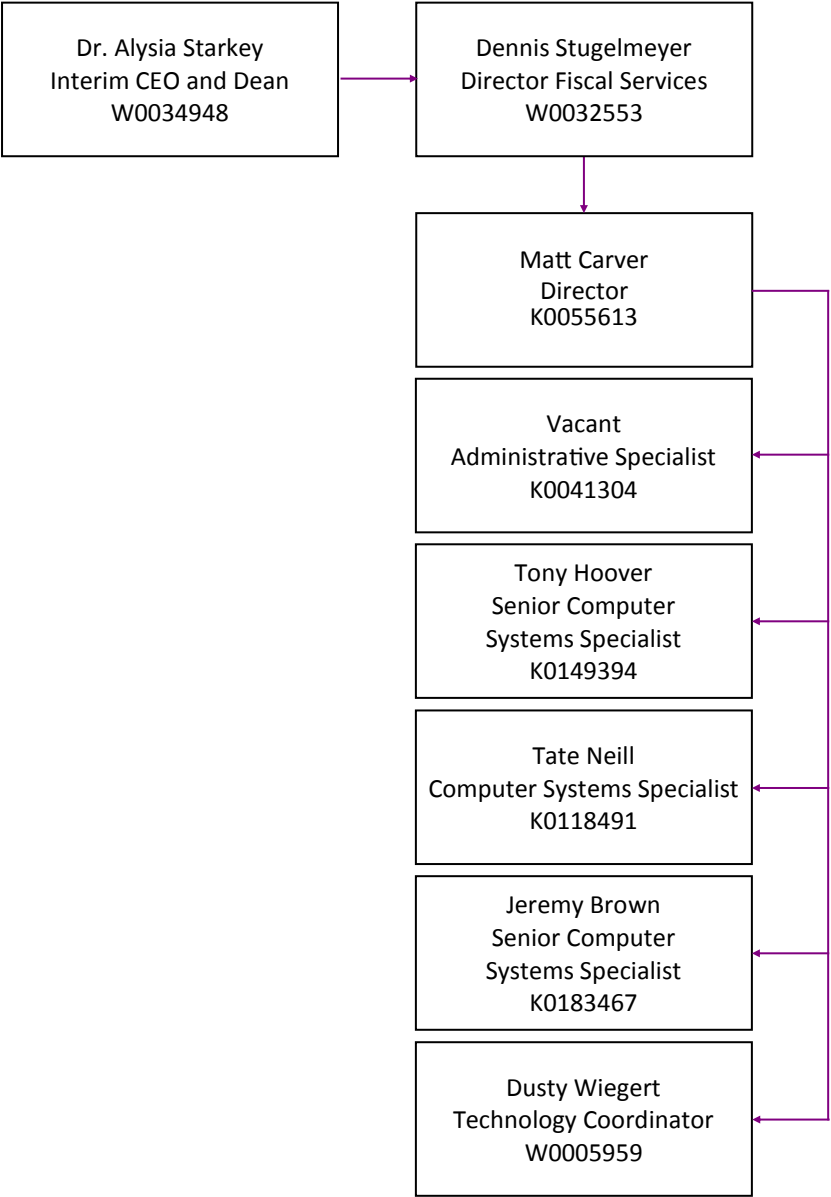

**Kansas State University Polytechnic Organization**  
**Auxiliary Services—85545**

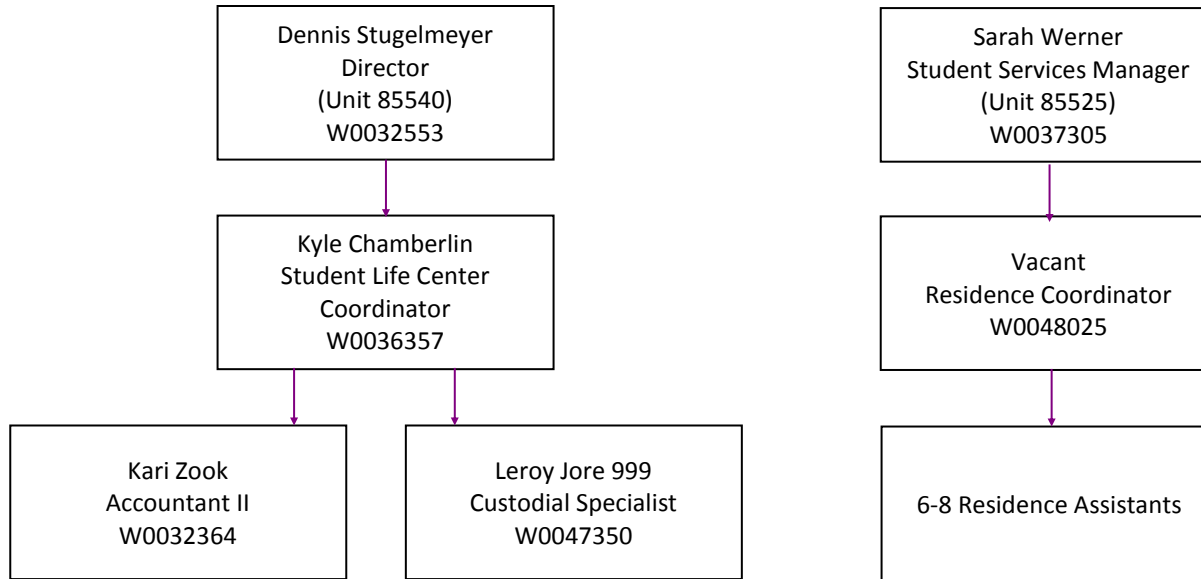

# Kansas State University Polytechnic Organization

## Flight Operations—85547

